

AR-7182WnA / AR-7182WnB

Quick Installation Guide

8-2013 / v1.0



COPYRIGHT

Copyright © Edimax Technology Co., Ltd. all rights reserved. No part of this publication may be reproduced, transmitted, transcribed, stored in a retrieval system, or translated into any language or computer language, in any form or by any means, electronic, mechanical, magnetic, optical, chemical, manual or otherwise, without the prior written permission from Edimax Technology Co., Ltd.

Edimax Technology Co., Ltd. makes no representations or warranties, either expressed or implied, with respect to the contents hereof and specifically disclaims any warranties, merchantability, or fitness for any particular purpose. Any software described in this manual is sold or licensed as is. Should the programs prove defective following their purchase, the buyer (and not this company, its distributor, or its dealer) assumes the entire cost of all necessary servicing, repair, and any incidental or consequential damages resulting from any defect in the software. Edimax Technology Co., Ltd. reserves the right to revise this publication and to make changes from time to time in the contents hereof without the obligation to notify any person of such revision or changes.

The product you have purchased and the setup screen may appear slightly different from those shown in this QIG. For more information about this product, please refer to the user manual on the CD-ROM. The software and specifications are subject to change without notice. Please visit our website www.edimax.com for updates. All brand and product names mentioned in this manual are trademarks and/or registered trademarks of their respective holders.

Edimax Technology Co., Ltd.

Add: No. 3, Wu-Chuan 3rd Rd., Wu-Ku Industrial Park, New Taipei City, Taiwan

Tel: +886-2-77396888

Email: sales@edimax.com.tw

Multi-Language Quick Installation Guide (QIG) on the CD

Čeština: Českého průvodce rychlou instalací naleznete na přiloženém CD s ovladači

Deutsch: Finden Sie bitte das deutsche S.A.L. beiliegend in der Treiber CD

Español: Incluido en el CD el G.R.I. en Español.

Français: Veuillez trouver l'français G.I.R ci-joint dans le CD

Italiano: Incluso nel CD il Q.I.G. in Italiano.

Magyar: A magyar telepítési útmutató megtalálható a mellékelt CD-n

Nederlands: De nederlandse Q.I.G. treft u aan op de bijgesloten CD

Polski: Skrócona instrukcja instalacji w języku polskim znajduje się na załączonej płycie CD

Português: Incluído no CD o G.I.R. em Portugues

Русский: Найдите Q.I.G. на русском языке на приложенном CD

Türkçe: Ürün ile beraber gelen CD içinde Türkçe Hızlı Kurulum Kılavuzu'nu bulabilirsiniz

Українська: Для швидкого налаштування Вашого пристрою, будь ласка, ознайомтесь з інструкцією на CD

PRODUCT INTRODUCTION

Package Contents

Before you start using this product, please check if there is anything missing in the package and contact your dealer to claim the missing item(s):

- ADSL2+ router (AR-7182WnA or AR-7182WnB)
- 12V power adapter
- 1 meter RJ-45 Ethernet cable
- 1.8M RJ-11 telephone line x 2
- Quick installation guide
- CD containing setup wizard, user manual & multi-language QIG
- Splitter
- 5dBi antenna



System Requirements

- A 10/100 base-T Ethernet card installed in your PC.
- A hub or switch (connected to several PCs through one of the Ethernet interfaces on the device).
- Windows 98 SE, Windows 2000, Windows ME, Windows XP, Windows 7, Windows 8.
- Internet Explorer V5.0 or higher, Netscape V4.0 or higher or Firefox 1.5 or higher.

LED Status

Front Panel:



LED	Color	Status	Description
Power 	Green	On	ADSL2+ router is on.
		Off	ADSL2+ router is off.
	Red	On	ADSL broadband initial self-test failed or upgrading firmware.
ADSL	Green	On	ADSL line is synchronized and ready to use.
		Slow Flashing	ADSL synchronization failed (please refer to <i>Note i.</i> below)
		Quick Flashing	ADSL negotiation is in progress.
Internet	Green	On	Internet connected in router mode
		Flashing	Internet activity (transferring/receiving data) in router mode.
		Off	Device in bridged mode.
	Red	On	Internet not connected in router mode (Please refer to <i>Note ii.</i> below).
LAN	Green	On	LAN port connected.
		Flashing	LAN activity (transferring/receiving data).
		Off	LAN port not connected.
WLAN 	Green	On	Successful WLAN connection.
		Flashing	WLAN activity (transferring/receiving data).
		Off	WLAN connection failed.
WPS	Green	Off	WPS is disabled.
		Flashing	WPS is enabled and waiting for client to negotiate.



 **Note i.**

If the ADSL LED is off, please check your Internet connection. Refer to A. Hardware Installation for more information about how to connect the router correctly. If all connections are correct, please contact your ISP to check if there is a problem with your Internet service.

- ii.** *If the Internet LED is red, please check your ADSL LED first. If the ADSL LED is off, refer to Note 1. If the green ADSL LED is ON, please check your Internet configuration. You may need to check with your ISP that your Internet is configured correctly.*

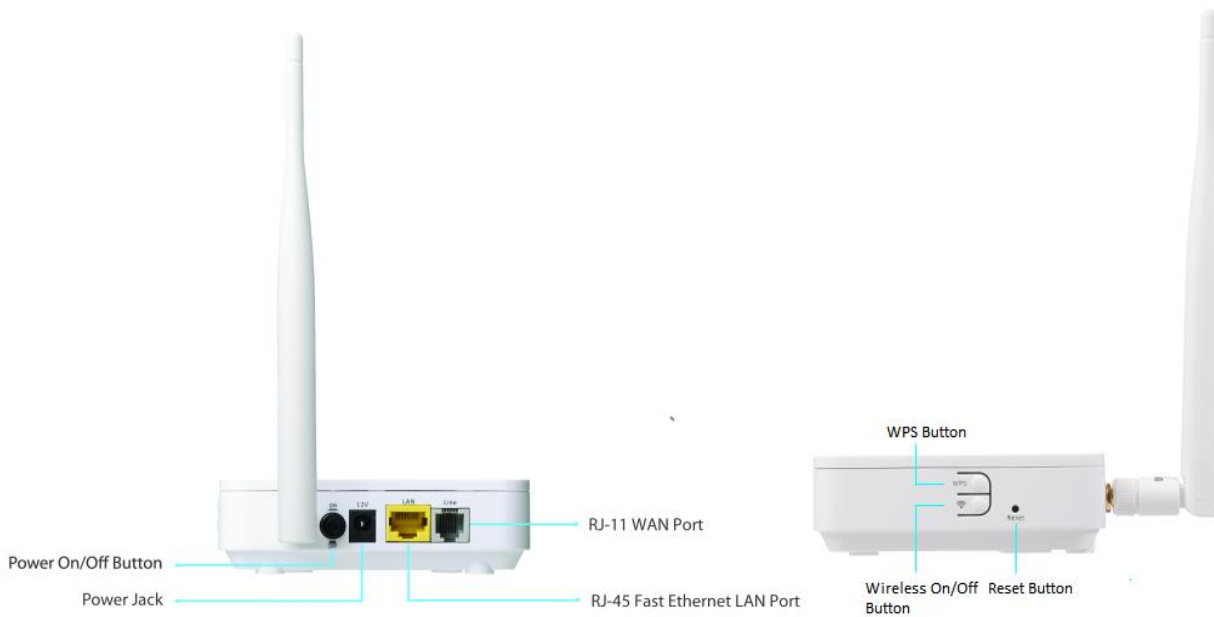
Rear Panel:



Item	Description
Power On/Off Button 	Switches the router on or off.
Power	Power port for included 12V power adapter.
Wireless On/Off Button 	Switch the wireless signal on or off.
WPS Button	Activate WPS (Wi-Fi Protected Setup)
LAN	RJ-45 Ethernet port.
Reset Button	Hold for less than 5 seconds to restart the device, and hold for more than 10 seconds to reset the device to factory default settings.
Line	RJ-11 port for standard telephone line.

GETTING STARTED

A. Hardware Installation

1. Connect the ADSL line.

Connect the line port of the router of the device to the modem interface of a splitter using a telephone cable. Connect a telephone to the Phone interface of the splitter using a telephone cable. Connect the Line interface of the splitter to your existing, incoming line.

The splitter has three interfaces:

- Line: Connect to a wall phone jack (RJ-11 jack).
- Modem: Connect to the ADSL jack of the device.
- Phone: Connect to a telephone set.

2. Connect the router to your LAN network.

Connect the LAN interface of the router to your PC, hub or switch using an Ethernet cable.

3. Connect the power adapter to the router.

Plug one end of the power adapter into a wall outlet and connect the other end to the 12V interface of the device. The following diagram shows how to correctly connect the router, PC, splitter and telephone sets.

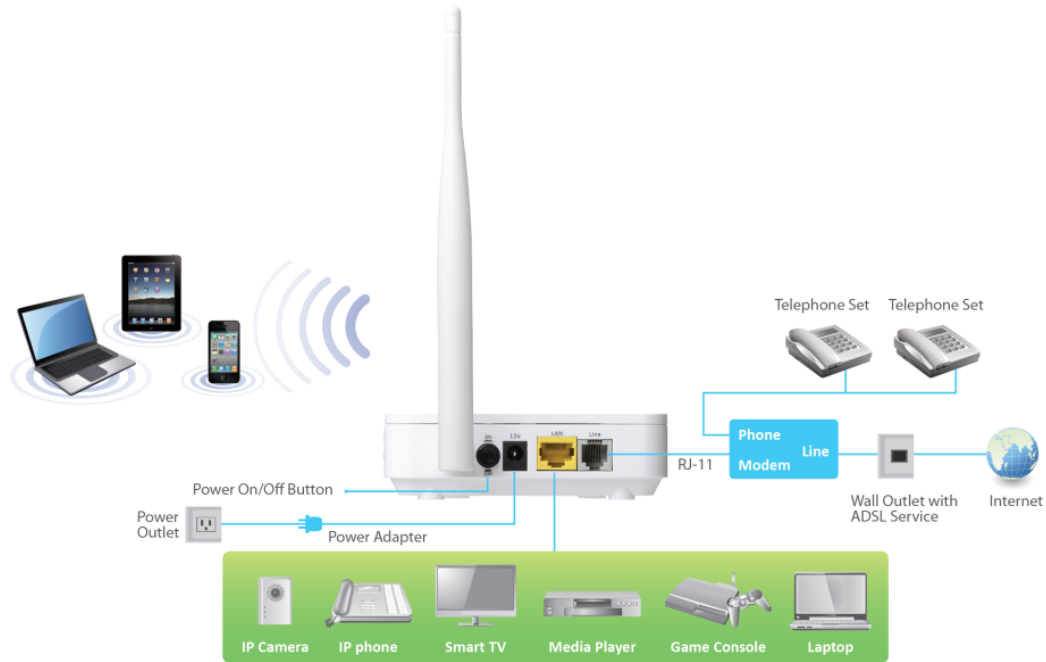

4. Check the ADSL LED status.

Please check the ADSL LED on the front panel. This light indicates the status of your ADSL broadband through your telephone line. If the light is on, you can continue setup. However if the light is flashing, there is no broadband line detected. Please call your Internet Service Provider (ISP) and inform them about the flashing ADSL light to resolve the issue.

5. Firewall settings.

Please turn off all personal firewalls before you continue the setup – firewalls can block communication between your PC and router.

Note: You must use the power adapter included in the package with the router, do NOT attempt to use a third-party power adapter.

6. PC LAN IP configuration.

Configure your PC's LAN settings to automatically obtain an IP address from the router by following the steps below:

1. Click **“Start”** and then select **“Control Panel”**.



2. Click **“Switch to Classic View”** in the top left to show additional setting icons.

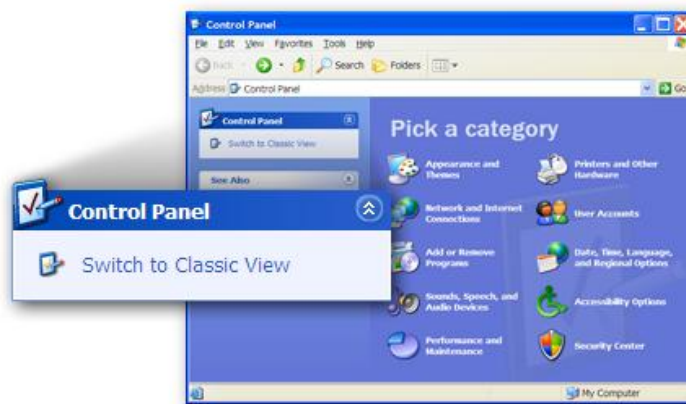

3. Locate the **“Network Connections”** icon and double-click to open network connection settings.



4. Select the **“Local Area Connection”** icon and right-click it to open the sub-menu, then select **“Properties”**.

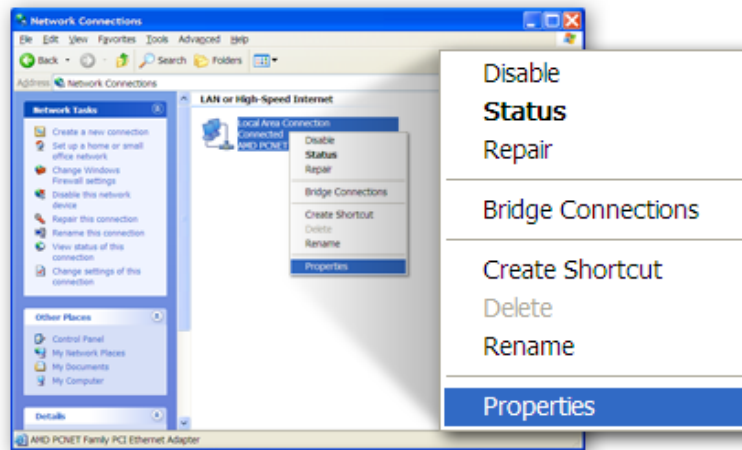

5. Select **“Internet Protocol (TCP/IP)”** and then click **“Properties”**

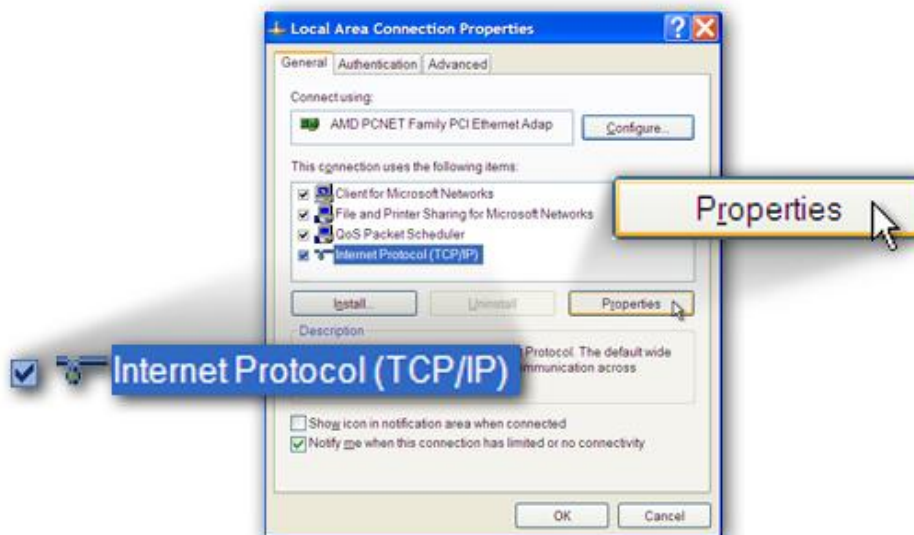

6. Ensure that **“Obtain an IP address automatically”** and **“Obtain DNS server address automatically”** are selected and then press **“OK”**.



B. Internet Connection

You can configure the router by running the setup wizard on the CD-ROM included in the package contents. The wizard enables you to configure your Internet connection, upgrade the firmware and change the router's password. When you start the setup wizard, you will see the following screen. Please choose a language and follow the on screen instructions until setup is complete.

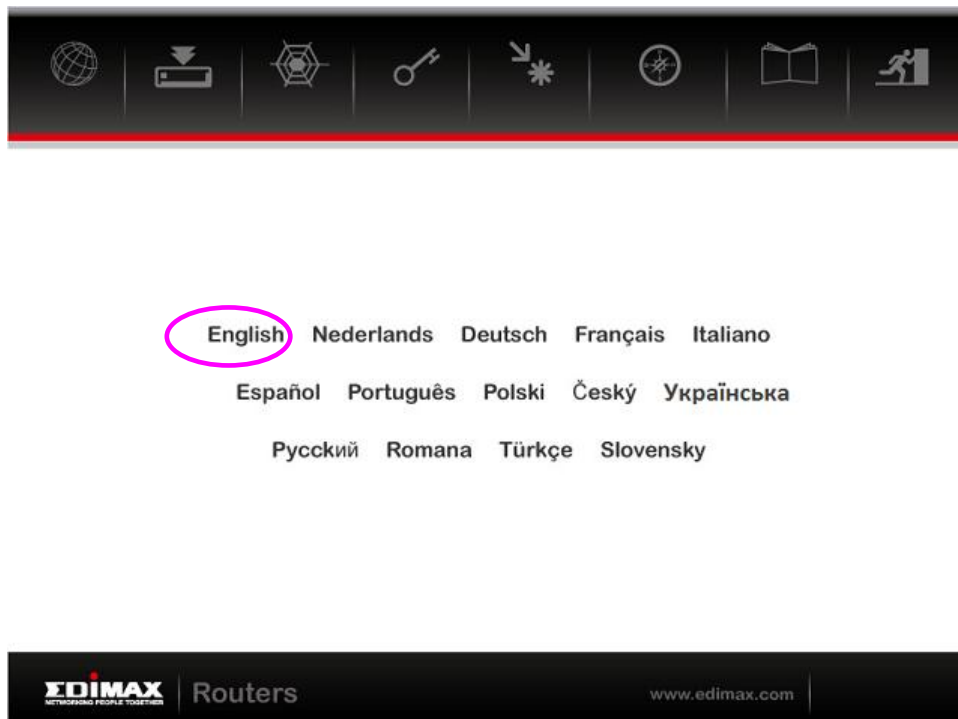

Alternatively, if you lose the CD-ROM or prefer a web based setup, you can login to the ADSL router using Internet Explorer, and configure the router from there using the web-based interface. Please follow the instructions below:

1. Enter the router's default IP address: **"192.168.2.1"** into your PC's web browser and press **"Enter"**.

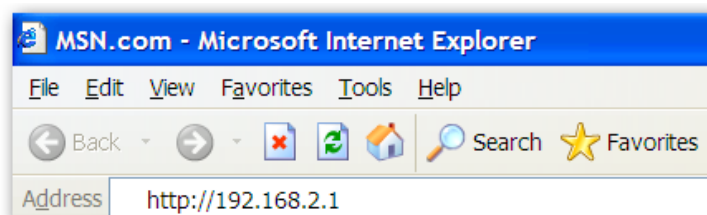

- The login screen below will appear. Enter the default username “**admin**” and default password “**1234**” and click “**OK**”.



- You will arrive at the system status page as shown below.

EDIMAX
NETWORKING PEOPLE TOGETHER

ADSL Router

Status	Quick Start	Interface Setup	Advanced Setup	Access Management	Maintenance	Status
	Device Info	System Log	Statistics			
Device Information	Model Name : AR-7182WnA Software Version : V1.0.1 MAC Address : 00:1f:a4:92:89:1f					
LAN	IP Address : 192.168.2.1 Subnet Mask : 255.255.255.0 DHCP Server : Enabled					
WAN	Virtual Circuit : PVC0 Status : Not Connected Connection Type : Bridge IP Address : N/A Subnet Mask : N/A Default Gateway : N/A Primary DNS : N/A Secondary DNS : N/A					
ADSL	ADSL Firmware Version : FwVer:3.20.29.0_TC3087 HwVer:T14.F7_11.2 Line State : Down Modulation : N/A Annex Mode : N/A					
		Downstream	Upstream			
	SNR Margin :	N/A	N/A	db		
	Line Attenuation :	N/A	N/A	db		
	Data Rate :	N/A	N/A	kbps		

4. In the navigation bar across the top of the screen, click “**Quick Start**” and then “**RUN WIZARD**”. The Wizard page of the web-based interface allows fast configuration of the Internet connection and other parameters. Please refer to the user manual for detailed information on these parameters.

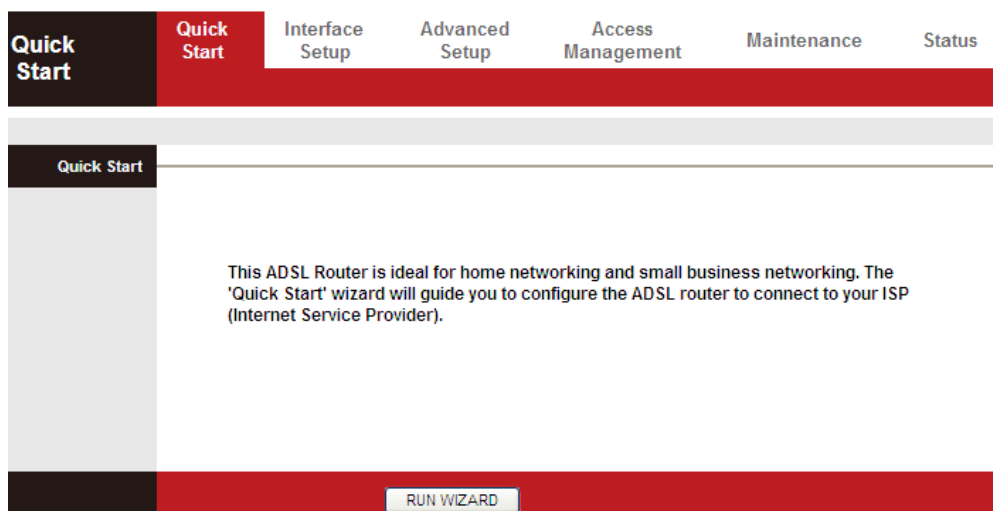

5. Follow the on screen instructions until the wizard is complete.

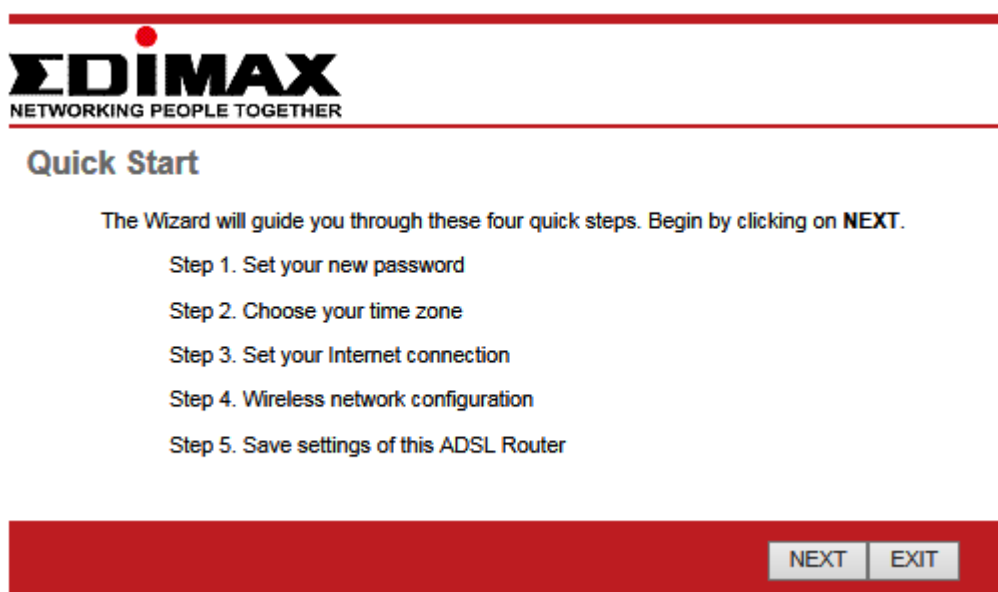

Note: Please refer to the User Manual on the included CD-ROM for more detailed information regarding configuration and Internet connection type.

EU Declaration of Conformity

- English:** This equipment is in compliance with the essential requirements and other relevant provisions of Directive 1999/5/EC, 2009/125/EC.
- French:** Cet équipement est conforme aux exigences essentielles et autres dispositions de la directive 1999/5/CE, 2009/125/CE
- Czechian:** Toto zařízení je v souladu se základními požadavky a ostatními příslušnými ustanoveními směrnic 1999/5/ES, 2009/125/ES.
- Polish:** Urządzenie jest zgodne z ogólnymi wymaganiami oraz szczególnymi warunkami określonymi Dyrektywą UE 1999/5/EC, 2009/125/EC
- Romanian:** Acest echipament este în conformitate cu cerințele esențiale și alte prevederi relevante ale Directivei 1999/5/CE, 2009/125/CE.
- Russian:** Это оборудование соответствует основным требованиям и положениям Директивы 1999/5/EC, 2009/125/EC.
- Magyar:** Ez a berendezés megfelel az alapvető követelményeknek és más vonatkozó irányelveknek (1999/5/EK, 2009/125/EC)
- Türkçe:** Bu cihaz 1999/5/EC, 2009/125/EC direktifleri zorunlu istekler ve diğer hükümlerle ile uyumludur.
- Ukrainian:** Обладнання відповідає вимогам і умовам директиви 1999/5/EC, 2009/125/EC.
- Slovakian:** Toto zariadenie spĺňa základné požiadavky a ďalšie príslušné ustanovenia smerníc 1999/5/ES, 2009/125/ES.
- German:** Dieses Gerät erfüllt die Voraussetzungen gemäß den Richtlinien 1999/5/EC, 2009/125/EC.
- Spanish:** El presente equipo cumple los requisitos esenciales de la Directiva 1999/5/EC, 2009/125/EC.
- Italian:** Questo apparecchio è conforme ai requisiti essenziali e alle altre disposizioni applicabili della Direttiva 1999/5/CE, 2009/125/CE.
- Dutch:** Dit apparaat voldoet aan de essentiële eisen en andere van toepassing zijnde bepalingen van richtlijn 1999/5/EC, 2009/125/EC.
- Portuguese:** Este equipamento cumpre os requisitos essenciais da Directiva 1999/5/EC, 2009/125/EC
- Norwegian:** Dette utstyret er i samsvar med de viktigste kravene og andre relevante regler i Direktiv 1999/5/EC, 2009/125/EC.
- Swedish:** Denna utrustning är i överensstämmelse med de väsentliga kraven och övriga relevanta bestämmelser i direktiv 1999/5/EG, 2009/125/EG.
- Danish:** Dette udstyr er i overensstemmelse med de væsentligste krav og andre relevante forordninger i direktiv 1999/5/EC, 2009/125/EC.
- Finnish:** Tämä laite täyttää direktiivien 1999/5/EY, 2009/125/EY oleelliset vaatimukset ja muut asiaankuuluvat määräykset.

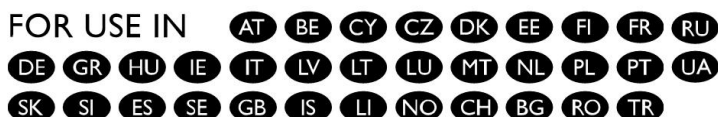
FOR USE IN 



WEEE Directive & Product Disposal



At the end of its serviceable life, this product should not be treated as household or general waste. It should be handed over to the applicable collection point for the recycling of electrical and electronic equipment, or returned to the supplier for disposal.

Declaration of Conformity

We, Edimax Technology Co., LTD., declare under our sole responsibility, that the equipment described below complies with the requirements of the European Council directive (1995/5/EC, 2006/95/EC).

Equipment : N150 Wireless ADSL Modem Router
Model No. : AR-7182WnA & AR-7182WnB

The following European standards for essential requirements have been followed:

Spectrum : ETSI EN 300 328 : V1.7.1(2006-10)
EMC : EN 301 489-1 V1.9.2(2011-09)
EN 301 489-17 V2.2.1(2012-09)
EMF : EN 62311 : 2008
Safety (LVD) : IEC 60950-1 :
2005 (2ndEdition)+A1 :2009
EN 60950-1 :
2006+A11:2009+A1:2010+A12:2011
Eco-design : EN 50564:2011

Edimax Technology Co., Ltd.
No. 3, Wu Chuan 3rd Road,
Wu-Ku Industrial Park.
New Taipei City, Taiwan



Date of Signature: August, 2013

Signature:

A handwritten signature in black ink, appearing to read 'Albert Chang', written over a white background.

Printed Name: Albert Chang

Title: Director

Edimax Technology Co., Ltd.



EDIMAX Technology Co., Ltd.

www.edimax.com